

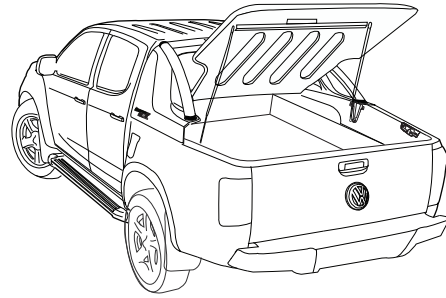

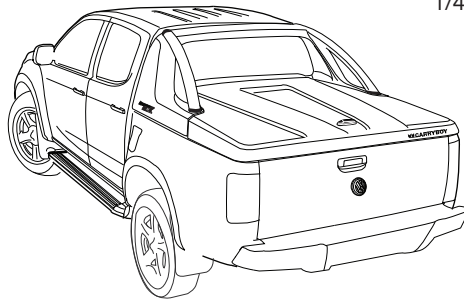

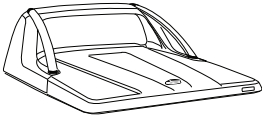

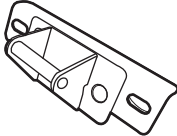

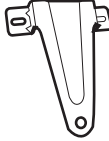

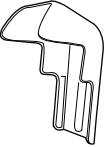
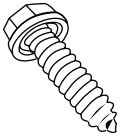
1/4







VOLKSWAGEN AMAROK

INSTALLATION PARTS

 <p>1 Sport lid 1 set.</p>	 <p>2 Latch 2 sets.</p>	 <p>3 Gas strut mounting bracket 2 pcs.</p>	 <p>4 Gas strut 2 pcs.</p>	 <p>5 Kwicklamp 4 pcs.</p>
 <p>6 Plastic cover kwick klamp 4 pcs.</p>	 <p>7 Head tapping screw 1/4 x 1 8 pcs.</p>	 <p>8 Washer 8 pcs.</p>	 <p>9 Stopper washer 4 pcs.</p>	 <p>10 Sponge seal</p>
 <p>11 Cable tie 6" 15 pcs.</p>	 <p>12 Shock absorber sticker 2 pcs.</p>	 <p>13 Sticker resin carryboy sport lid GRX</p>	 <p>14 CARRYBOY emblem 1 pc.</p>	 <p>15 PVC sticker</p>

ATTENTION!
5000 km
Must check installation bolt and lubricate every 5,000 km.

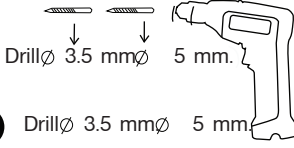
INSTALLATION TOOLS

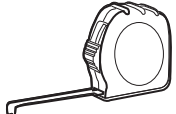
 <p>1 Wrench No. 12,13</p>	 <p>2 Torque wrench # 13</p>	 <p>3 Drill 3.5 mm 5 mm</p>	 <p>4 Screw driver</p>	 <p>5 Measuring tape</p>
---	--	---	--	--

WIRING DIAGRAM

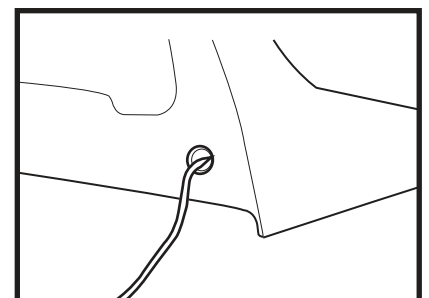
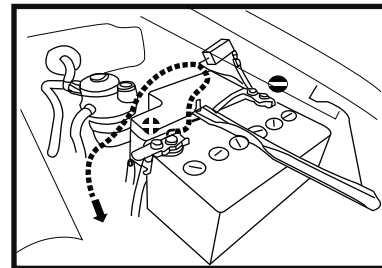
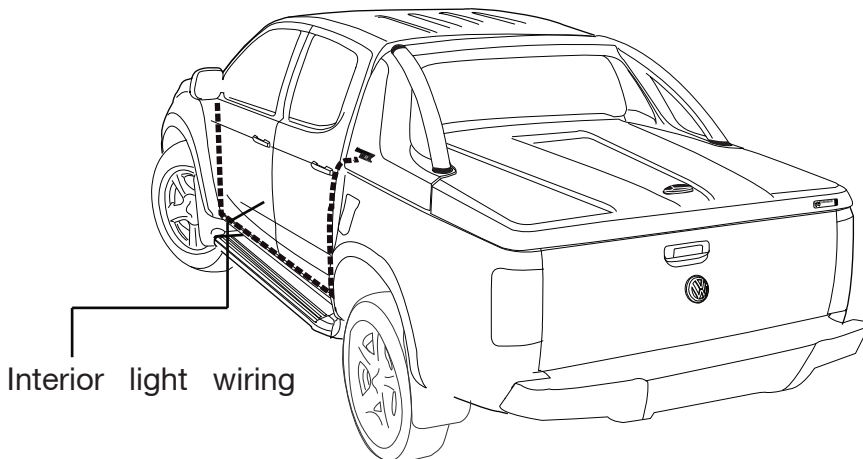

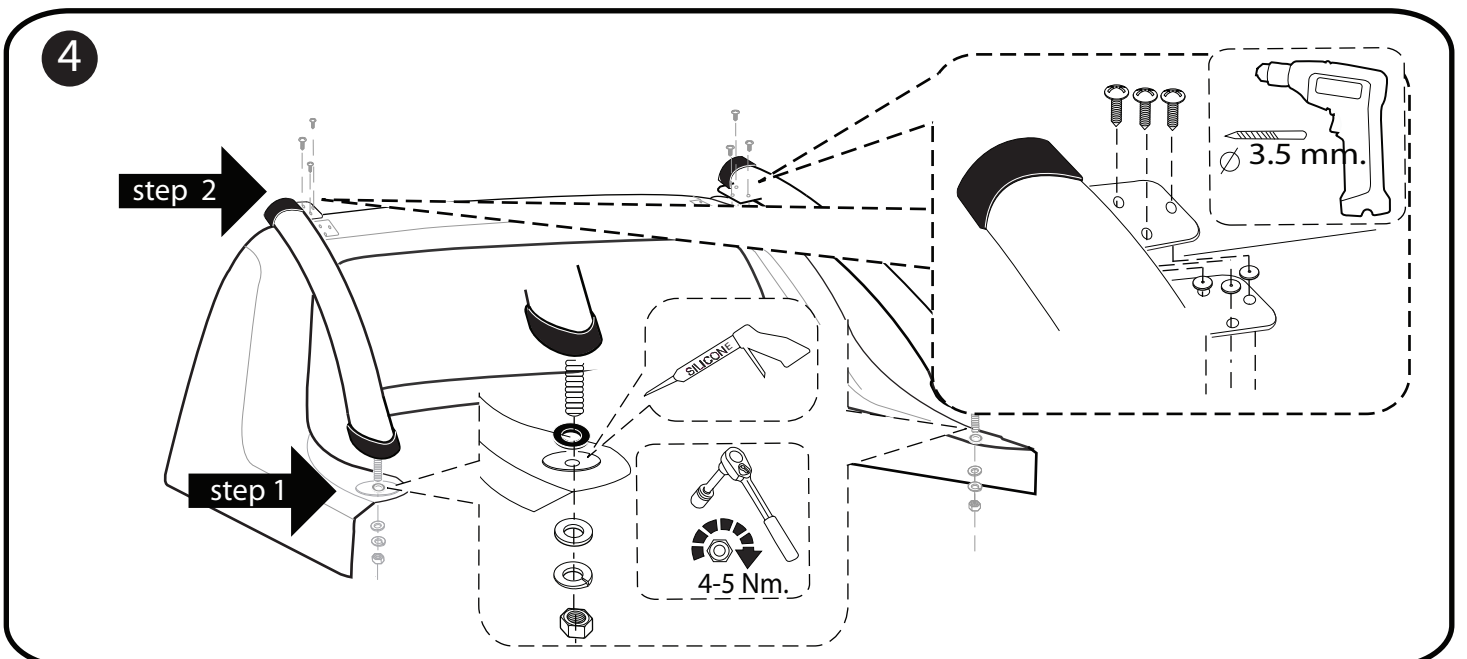
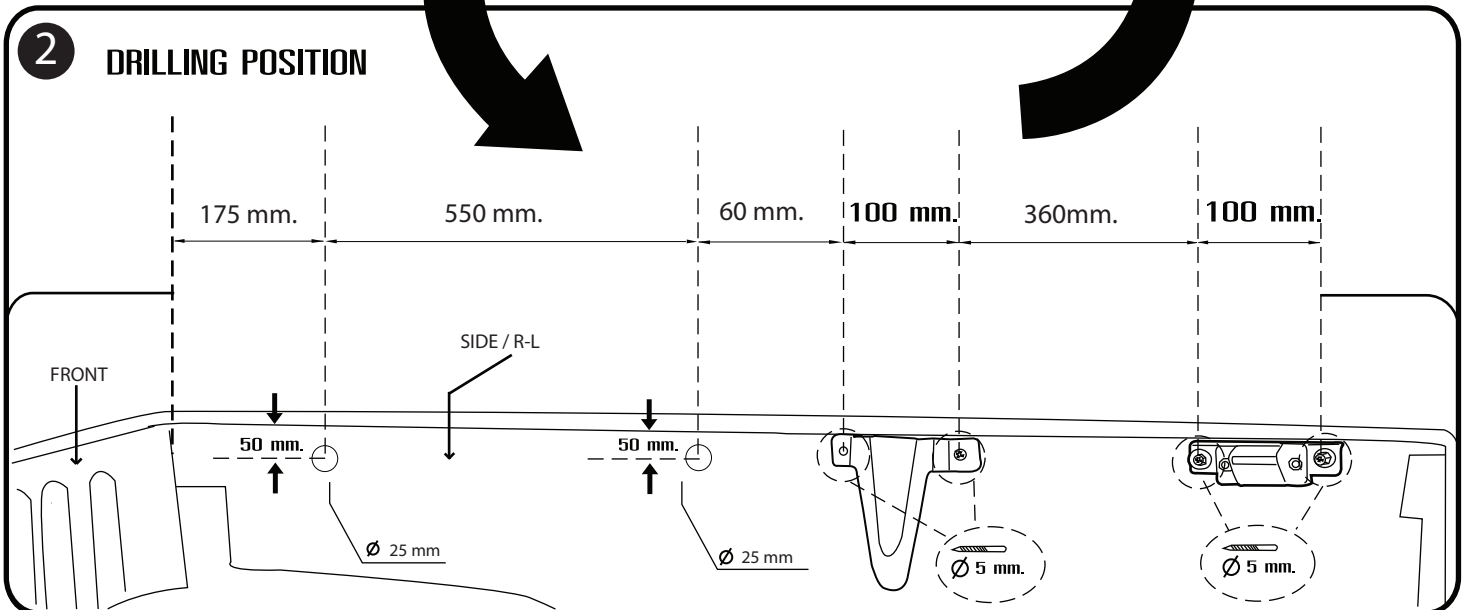
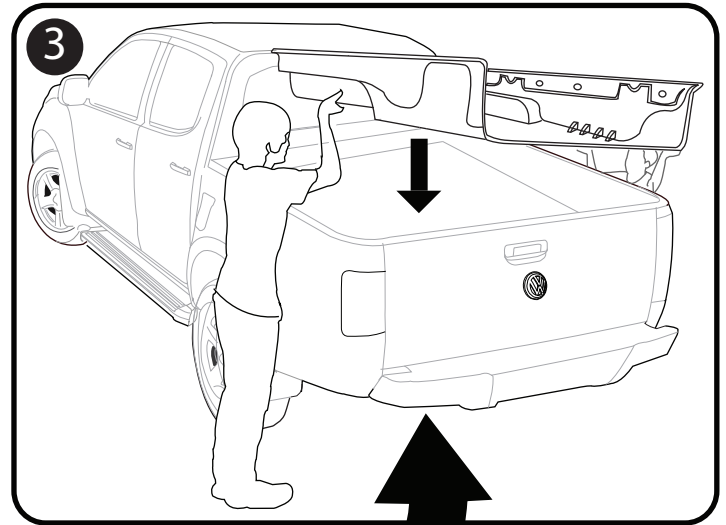
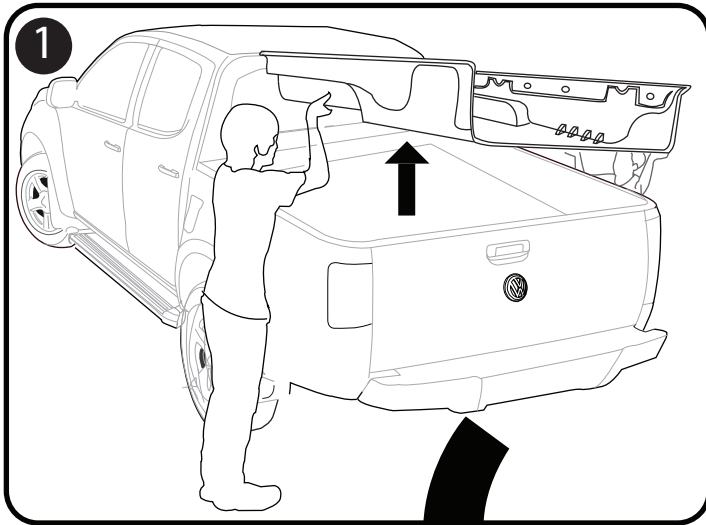

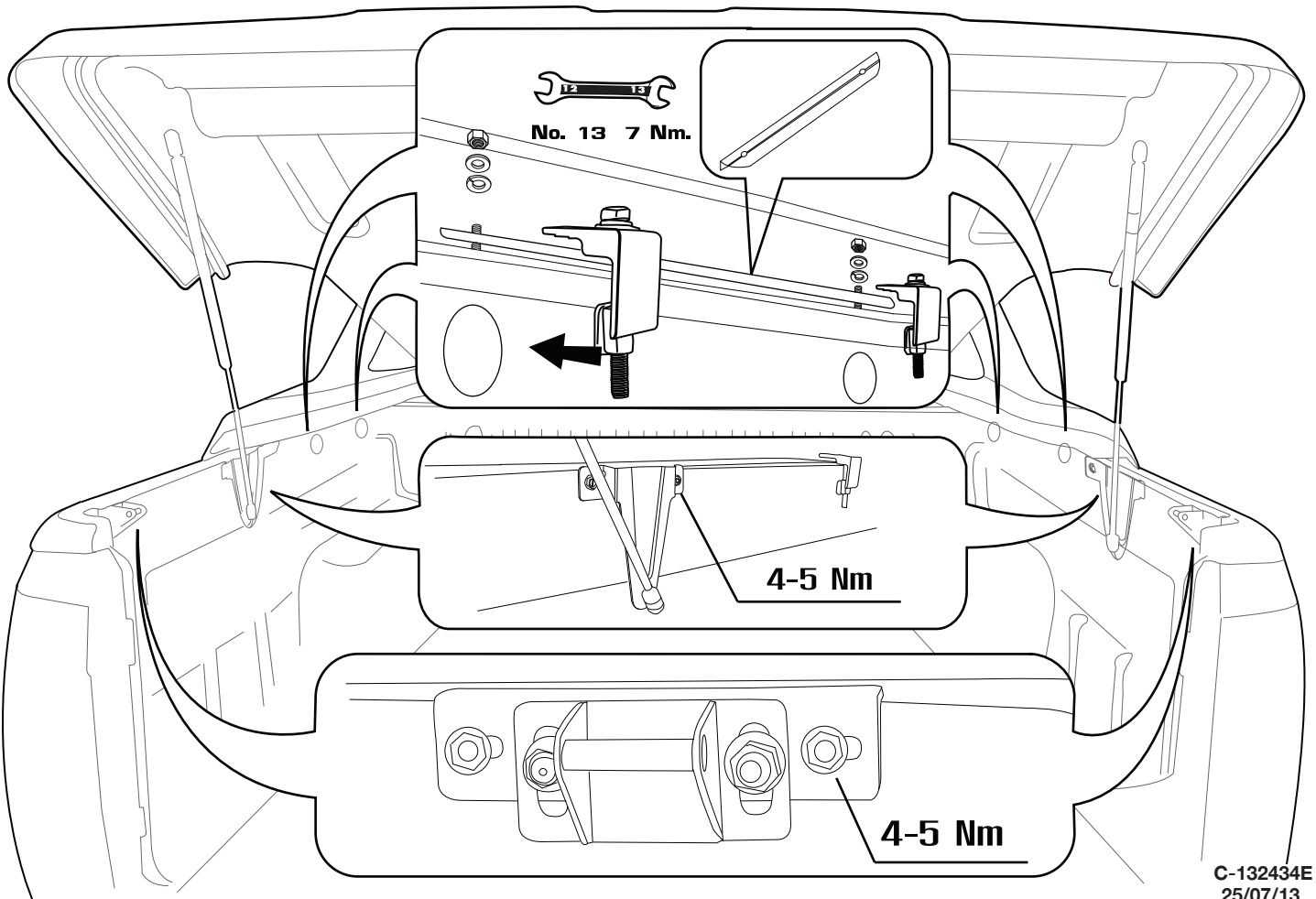
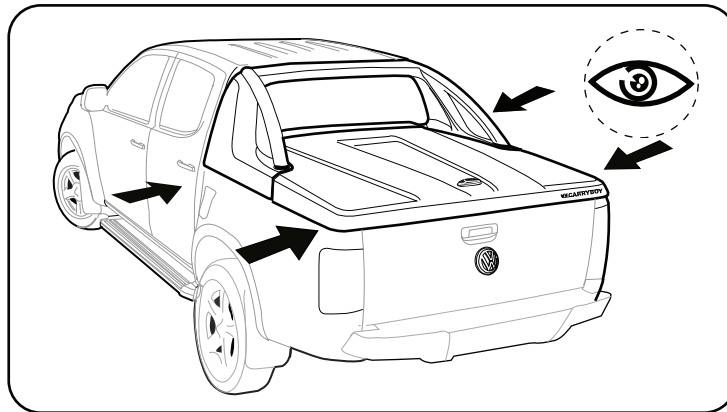
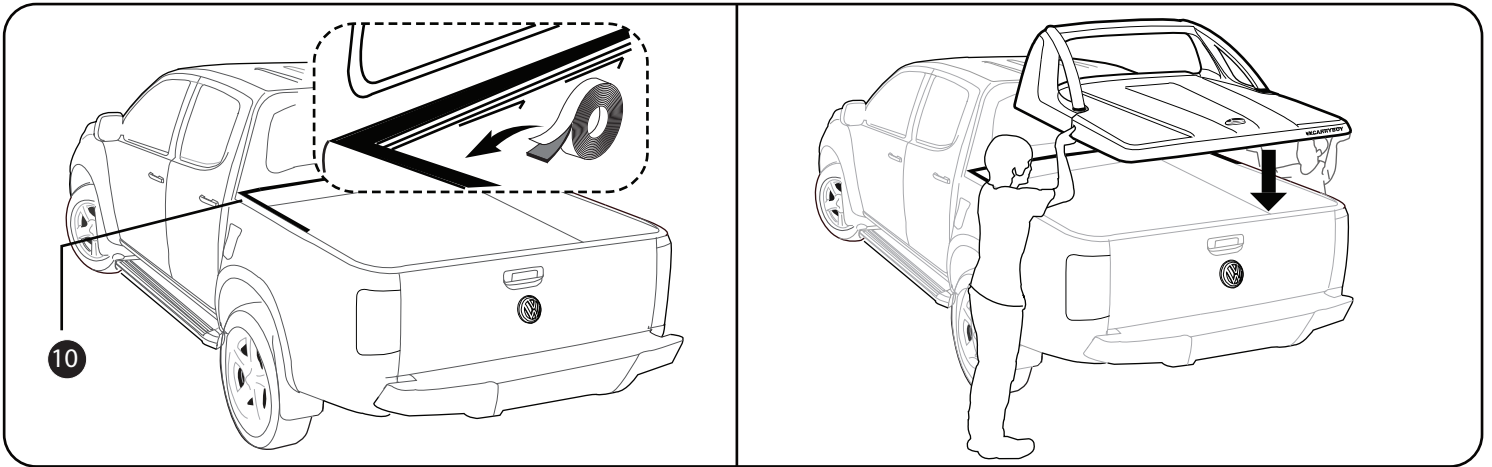

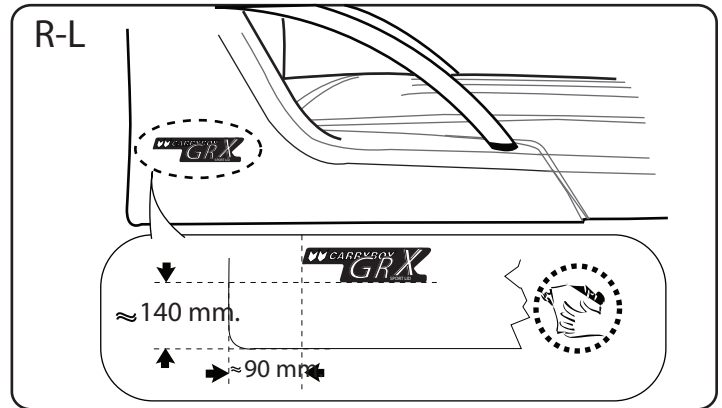
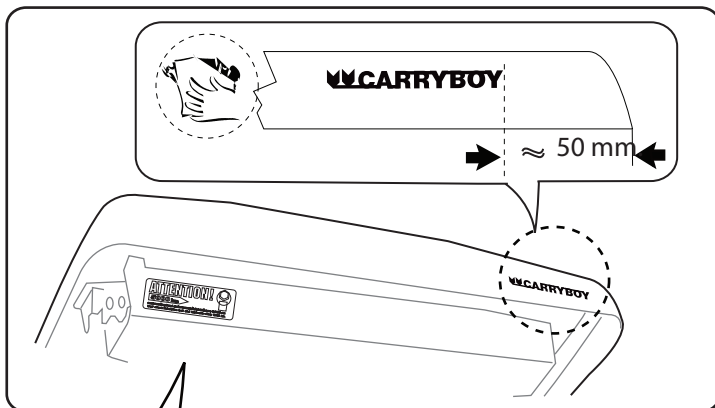
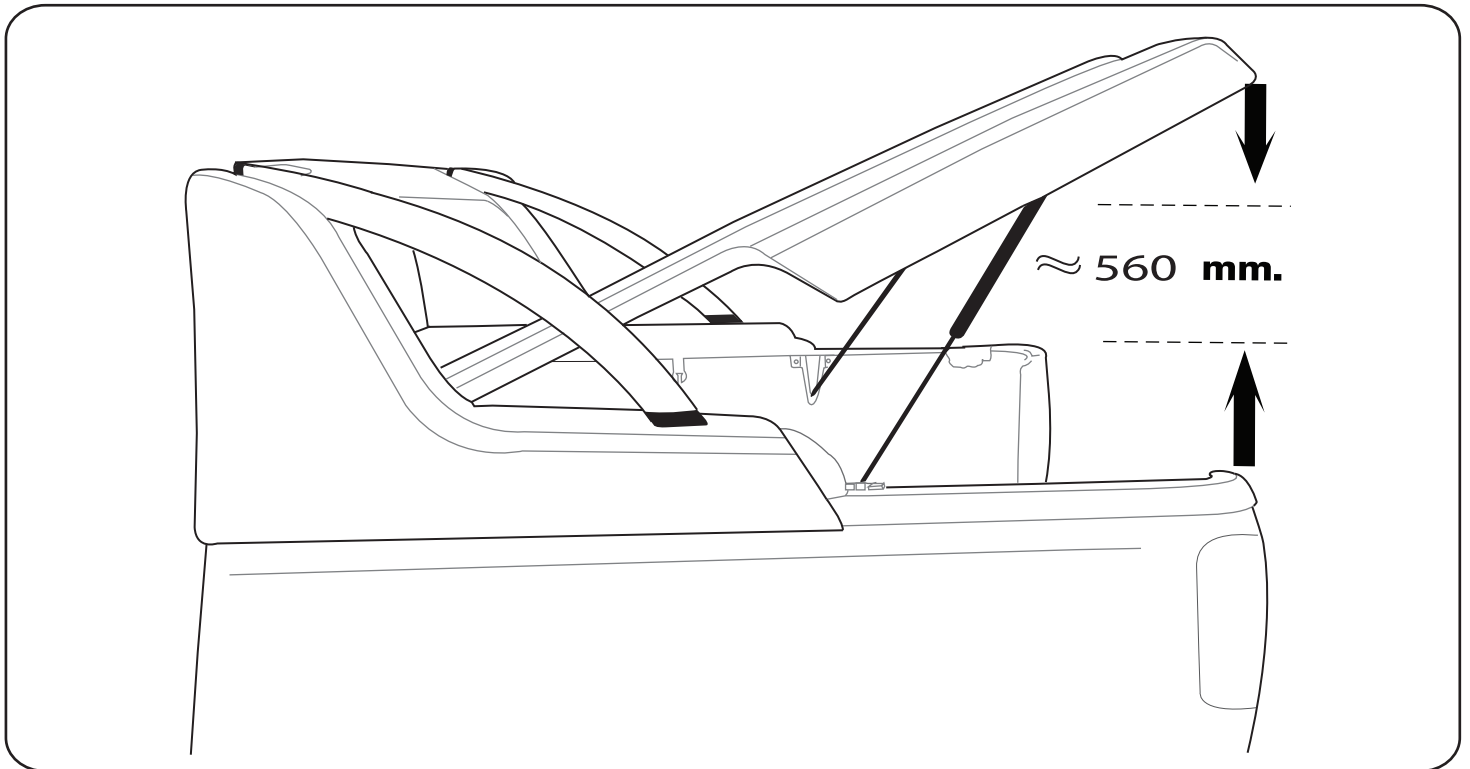
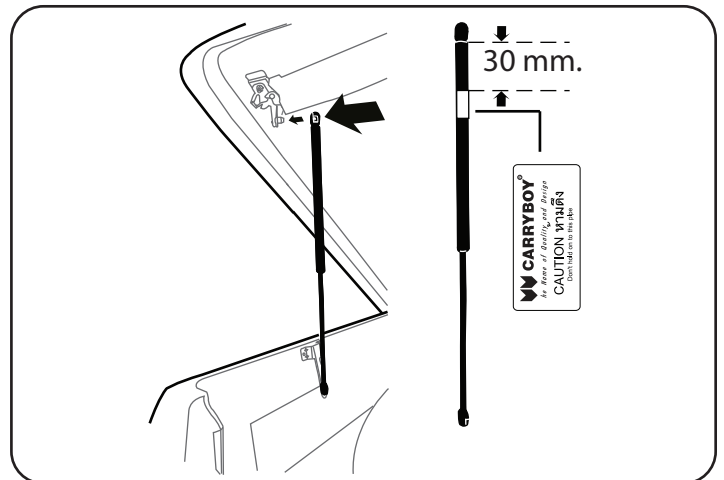
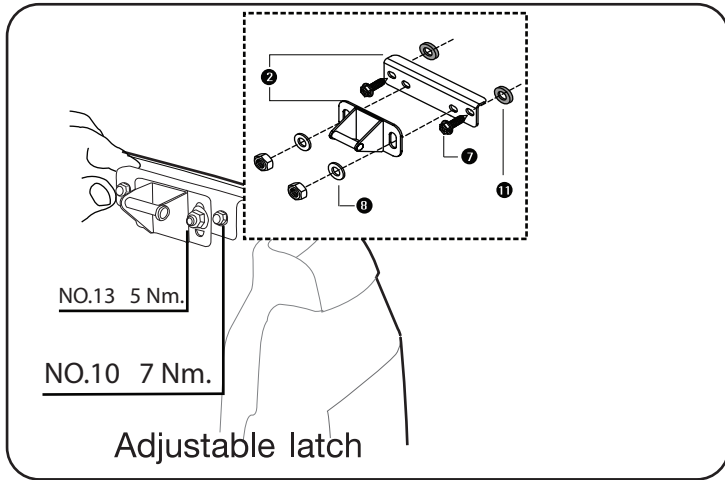

CAUTION

Tighten bolts, nuts, screws and lubricant parts every 5,000 km.